

User's Guide

for the

Ampeg

B500DR

Programmable Bass Amplifier



Made with Pride in the U.S.A. by











Ampeg

TABLE OF CONTENTS	
Introduction3
Features3
The Front Panel4
The Rear Panel5
Some Suggested Settings6
Rack Mounting6
Presets7
Programming the B500DR7
Troubleshooting7
Technical Specificationsback cover
System Block Diagramback cover

This equipment has been tested and found to comply with the limits for a Class B digital device, pursuant to part 15 of the FCC Rules. These limits are designed to provide reasonable protection against harmful interference in a residential installation. This equipment generates, uses and can radiate radio frequency energy and, if not installed and used in accordance with the instructions, may cause harmful interference to radio communications. However, there is no guarantee that interference will not occur in a particular installation. If this equipment does cause harmful interference to radio or television reception, which can be determined by turning the equipment off and on, the user is encouraged to try to correct the interference by one or more of the following measures:

- Reorient or relocate the receiving antenna.
- Increase the separation between the equipment and the receiver.
- Connect the equipment into an outlet on a circuit different from that to which the receiver is connected.
- Consult the dealer or an experienced radio/TV technician for help.

Changes or modifications to this device not expressly approved by SLM Electronics could void the user's authority to operate the equipment under FCC rules.

 <div style="border: 1px solid black; padding: 2px; text-align: center; font-weight: bold; font-size: small;">CAUTION</div> <div style="font-size: x-small; text-align: center;">RISK OF ELECTRIC SHOCK DO NOT OPEN</div>  <p style="font-size: x-small; margin-top: 5px;">WARNING: TO REDUCE THE RISK OF FIRE OR ELECTRIC SHOCK, DO NOT EXPOSE THIS APPARATUS TO RAIN OR MOISTURE. TO REDUCE THE RISK OF ELECTRIC SHOCK, DO NOT REMOVE COVER. NO USER-SERVICEABLE PARTS INSIDE. REFER SERVICING TO QUALIFIED SERVICE PERSONNEL.</p>	 <div style="border: 1px solid black; padding: 2px; text-align: center; font-weight: bold; font-size: small;">PRECAUCION</div> <div style="font-size: x-small; text-align: center;">RIESGO DE CORRIENTAZO NO ABRA</div>  <p style="font-size: x-small; margin-top: 5px;">PRECAUCION: PARA REDUCIR EL RIESGO DE INCENDIOS O DESCARGAS ELECTRICAS, NO PERMITA QUE ESTE APARATO QUEDA EXPUESTO A LA LLUVIA O LA HUMEDAD. PARA DISMINUIR EL RIESGO DE CORRIENTAZO, NO ABRA LA CUBIERTA. NO HAY PIEZAS SERVICIO QUE EL USUARIO PUEDO REPARAR DEJE TODO MANTENIMIENTO A LOS TECNICOS CALIFICADOS.</p>	 <div style="border: 1px solid black; padding: 2px; text-align: center; font-weight: bold; font-size: small;">ATTENTION</div> <div style="font-size: x-small; text-align: center;">RISQUE D'ELECTROCUTION NE PAS OUVRIR</div>  <p style="font-size: x-small; margin-top: 5px;">ATTENTION: PROTEGEZ CET APPAREIL DE LA PLUIE ET DE L'HUMIDITE AFIN D'EVITER TOUT RISQUE D'INCENDIE OU D'ELECTROCUTION. POUR REDUIRE D'ELECTROCUTION NE PAS ENLEVER LE COUVERCLE. AUCUNE PIECE INTERNE N'EST REPARABLE PAR L'UTILISATEUR. POUR TOUTE REPARATION, S'ADRESSER A UN TECHNICIEN QUALIFIE.</p>
IMPORTANT SAFETY INSTRUCTIONS		
<ul style="list-style-type: none"> • READ, FOLLOW, HEED, AND KEEP ALL INSTRUCTIONS AND WARNINGS. • DO NOT OPERATE NEAR ANY HEAT SOURCE AND DO NOT BLOCK ANY VENTILATION OPENINGS ON THIS APPARATUS. FOR PROPER OPERATION, THIS UNIT REQUIRES 3" (75CM) OF WELL VENTILATED SPACE AROUND HEATSINKS AND OTHER AIR FLOW PROVISIONS IN THE CABINET. • DO NOT USE THIS APPARATUS NEAR SPLASHING, FALLING, SPRAYING, OR STANDING LIQUIDS. • CLEAN ONLY WITH LINT-FREE DAMP CLOTH AND DO NOT USE CLEANING AGENTS. • ONLY CONNECT POWER CORD TO A POLARIZED, SAFETY GROUNDED OUTLET WIRED TO CURRENT ELECTRICAL CODES AND COMPATIBLE WITH VOLTAGE, POWER, AND FREQUENCY REQUIREMENTS STATED ON THE REAR PANEL OF THE APPARATUS. • PROTECT THE POWER CORD FROM DAMAGE DUE TO BEING WALKED ON, PINCHED, OR STRAINED. • UNPLUG THE APPARATUS DURING LIGHTNING STORMS OR WHEN UNUSED FOR LONG PERIODS OF TIME. • ONLY USE ATTACHMENTS, ACCESSORIES, STANDS, OR BRACKETS SPECIFIED BY THE MANUFACTURER FOR SAFE OPERATION AND TO AVOID INJURY. • WARNING: TO REDUCE THE RISK OF ELECTRIC SHOCK OR FIRE, DO NOT EXPOSE THIS UNIT TO RAIN OR MOISTURE. • SERVICE MUST BE PERFORMED BY QUALIFIED PERSONNEL. • OUR AMPLIFIERS ARE CAPABLE OF PRODUCING HIGH SOUND PRESSURE LEVELS. CONTINUED EXPOSURE TO HIGH SOUND PRESSURE LEVELS CAN CAUSE PERMANENT HEARING IMPAIRMENT OR LOSS. USER CAUTION IS ADVISED AND EAR PROTECTION IS RECOMMENDED IF UNIT IS OPERATED AT HIGH VOLUME. 		
EXPLANATION OF GRAPHICAL SYMBOLS: EXPLICACION DE SIMBOLOS GRAFICOS: EXPLICATION DES SYMBOLES GRAPHIQUES:	 = "DANGEROUS VOLTAGE" "VOLTAJE PELIGROSO" "DANGER HAUTE TENSION"	 = "IT IS NECESSARY FOR THE USER TO REFER TO THE INSTRUCTION MANUAL." "ES NECESARIO QUE EL USUARIO SE REFIERA AL MANUAL DE INSTRUCCIONES." "REFERREZ-VOUS AU MANUAL D'UTILISATION"

An Introduction to the Ampeg B500DR Programmable Bass Amplifier:

Thank you for making one of the best choices you will ever make for your musical career – choosing one of the finest bass amps available, the Ampeg B500DR. This programmable bass amplifier delivers up to 500 watts of unsurpassed musical power, and offers several outstanding features.

All of the features and controls of your B500DR are covered in detail within the pages of this user's guide. We recommend going over them before you use the amplifier.

Features:

In the world of high performance bass amps, Ampeg amplifiers stand alone. In true Ampeg tradition, the B500DR Programmable Bass Amplifier offers you more power, performance and flexibility than any other bass amp in its class. The outstanding features of your new amplifier, features which set it apart from the competition, are listed below.

- **FOUR PROGRAMMABLE PRESETS:** Program and keep four presets - access them with the front panel Preset pushbuttons *or* with the Ampeg AFP4BD four-button footswitch (supplied)
Complete information about the B500DR's presets and programs is on page 7.
- **TWO SWITCHABLE INPUTS:** Allows you to connect two instruments to the amplifier at one time, then switch between them without having to disconnect and reconnect any cables - saves time and eliminates distracting noise
- **INPUT PAD:** Useful for instruments with active and/or high output pickups
- **LED INDICATOR CONTROL KNOBS:** LEDs surrounding the Gain, EQ and Effects Blend controls provide a visual indication of their settings for the selected Preset
- **PEAK METER FEATURE:** The LEDs around the Gain control act as a Peak/VU meter
- **FX BLEND:** Varies the amount of external effects mixed into the signal
- **LIMIT CIRCUIT:** Built-in protection from overdriving the amplifier - can be disabled by the front panel Limit Defeat switch
- **HEAVY-DUTY SPEAKER JACKS:** A Speakon® jack is provided for a more reliable connection at higher outputs, as well as a pair of 1/4" jacks
- **BALANCED LINE OUTPUT:** Balanced XLR line output jack with Level control - switchable for Pre or Post EQ
- **EFFECTS LOOP:** Allows you to connect external effects to the amplifier
- **POWER AMP IN/PREAMP OUT:** A separate preamp may be connected to the Power Amp In jack, and the Preamp Out jack may be connected to a slave amp, or use as a patch point for active devices such as compressors, EQs, etc.
- **CIRCUIT BREAKER PROTECTION:** A heavy duty, resettable circuit breaker provides protection against fault conditions

The Front Panel:

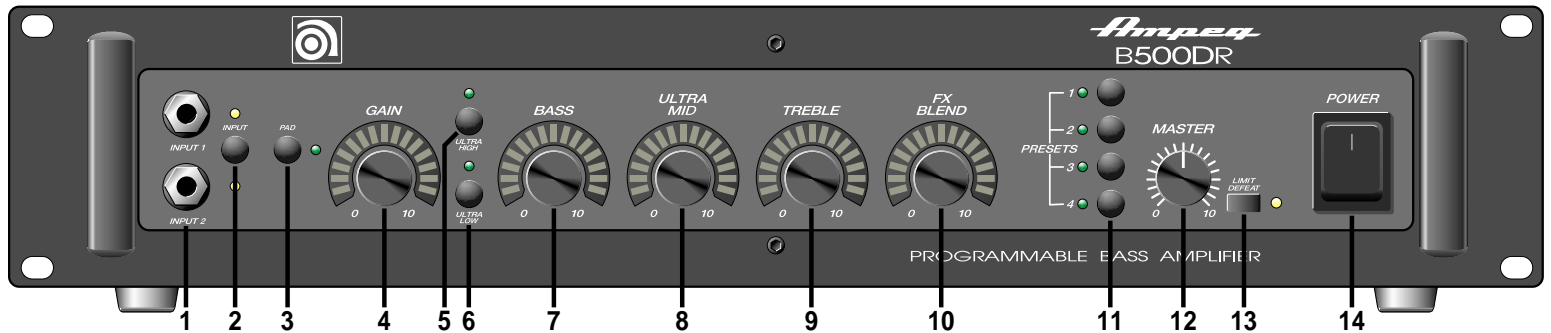

1. INPUT 1, INPUT 2: Use these jacks to connect your instrument(s) to the amplifier by means of a shielded instrument cable. Only one Input jack is active at a time, as determined by the Input switch (#2).

2. INPUT: Use this switch to select which of the Input jacks (#1) is active. The LEDs adjacent to the jacks indicate which of the Inputs is active. This feature is perfect in situations where a player switches between two instruments during a performance: you may start with the instrument connected to Input 1, for instance, then change to the instrument connected to Input 2 - without changing patch cords!

3. PAD: Use this switch to activate the input pad - if your instrument has active or high output pickups, activating the pad will allow you to set the Gain control (#4) at a more useable setting. The adjacent LED illuminates when the Pad is active.

4. GAIN: Use this control to adjust the input signal level. When a signal is present the LEDs around this control act as a Peak indicator: adjust the Gain control until the two LEDs furthest clockwise flash occasionally while playing. Once you have adjusted the Gain control, the LEDs serve as a VU meter and will illuminate according to the strength of the signal from your instrument.

5. ULTRA HIGH: Use this switch to boost the high frequencies. The adjacent LED illuminates when the Ultra High is active.

6. ULTRA LOW: Use this switch to boost the low frequencies. The adjacent LED illuminates when the Ultra Low is active.

7. BASS: Use this control to adjust the low frequency output of the amplifier.

8. ULTRA MID: Use this control to adjust the midrange frequency output of the amplifier.

9. TREBLE: Use this control to adjust the high frequency output of the amplifier.

10. FX BLEND: Use this control to adjust the mix between the direct (dry) signal and the effects (wet) when the effects loop (#24-25) is used. Full counterclockwise results in all direct signal (no effect) and full clockwise gives all effect and no direct signal. The clockwise position is equivalent to a series effects loop and should be used with such devices as limiters and equalizers.

11. PRESETS: Use these switches to select one of four presets for the amplifier. Complete information on presets and programs is on page 7.

12. MASTER: Use this control to adjust the overall output level of the amplifier.

13. LIMIT DEFEAT: The B500DR employs a limiter circuit to prevent overdrive distortion at or near full power. This switch, when depressed, disables the internal limiter circuit. The adjacent LED illuminates when the limiter circuit is operating.

14. POWER: Use this switch to turn the amplifier on (top of the switch depressed) and off (bottom of the switch depressed).

The Rear Panel:

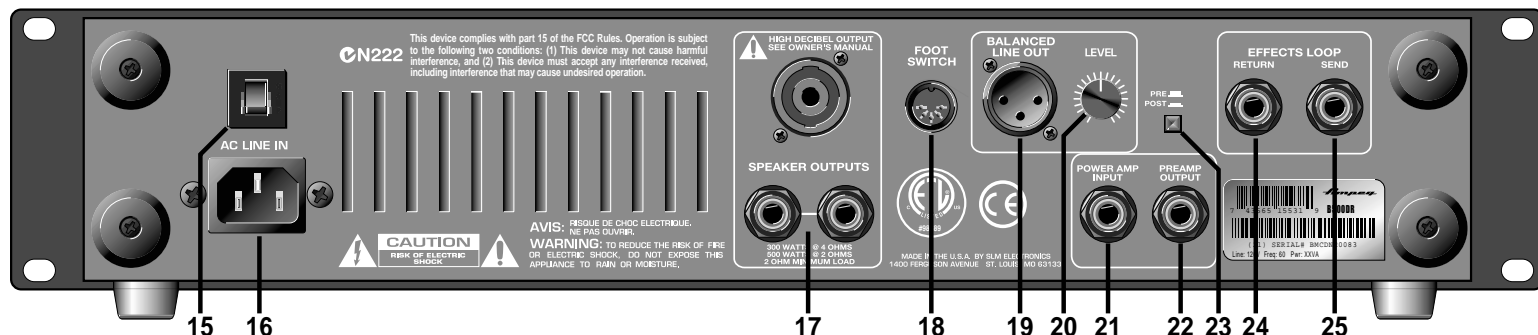

15. CIRCUIT BREAKER: The B500DR employs an AC line circuit breaker to help protect against damage due to excessive current demands. If the amplifier stops working, check the circuit breaker. If it has opened, the button will be protruding and showing a contrasting color. You can reset the circuit breaker by pushing it in until it latches. The breaker must cool down for a short time before the button will latch. If the circuit breaker opens repeatedly, have the amplifier checked by a qualified service person.

16. AC LINE IN: Firmly insert the supplied AC power cord into this socket until it is fully seated. This grounded power cord is to be plugged into a grounded power outlet, wired to current electric codes and compatible with voltage, power, and frequency requirements stated on the rear panel. **Do no attempt to defeat the safety ground connection.**

17. SPEAKER OUTPUTS: The 1/4" jacks offer a convenient method of connecting to speaker cabinets using cables terminated with 1/4" plugs. However, when using the amplifier at or near its full output power, using the Speakon® jack is recommended.

18. FOOTSWITCH: Use this jack to connect the Ampeg AFP4BD four button footswitch to the amplifier for remote selection of the four presets.

19. BALANCED LINE OUT: Use this jack to send a pre-Master, line level signal to a house mixing board, recording console or external amplifier(s). Pin 2 = positive (+), pin 3 = negative (-).

20. LEVEL: Use this control to adjust the level of the signal at the Balanced Line Out jack (#19).

21. POWER AMP INPUT: Use this jack to connect the output of an external preamp directly into the power amp circuitry of the B500DR by means of a shielded signal cable. The preamp signal is disengaged when this jack is used.

22. PREAMP OUTPUT: Use this jack to send a preamp signal to an external power amplifier, mixing board, external effects, etc. by means of a shielded instrument cable. Using this output does not break the connection to the internal power amplifier.

23. PRE/POST: This switch, when depressed, sends a post-EQ preamp signal to the Balanced Line Out jack (#19). The signal at the balanced Line Out jack (#19) is pre-EQ when this switch is in the out position.

24. EFFECTS LOOP RETURN: Use this jack to connect the B500DR to the output of an external effects device by means of a shielded signal cable.

27. EFFECTS LOOP SEND: Use this jack to connect the B500DR to the input of an external effects device by means of a shielded signal cable.

Some Suggested Settings

ROCK:

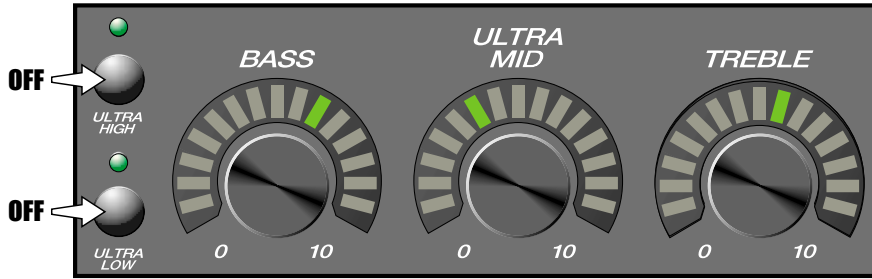

JAZZ:

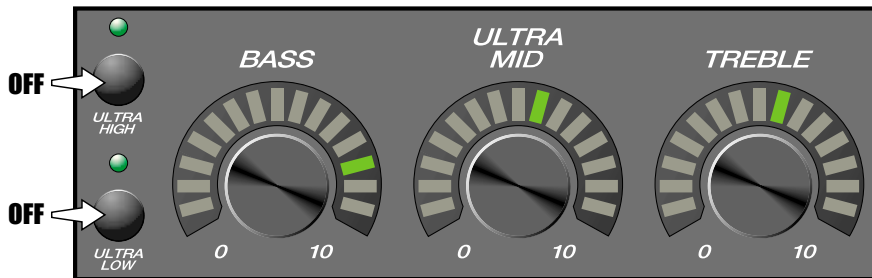

COUNTRY:

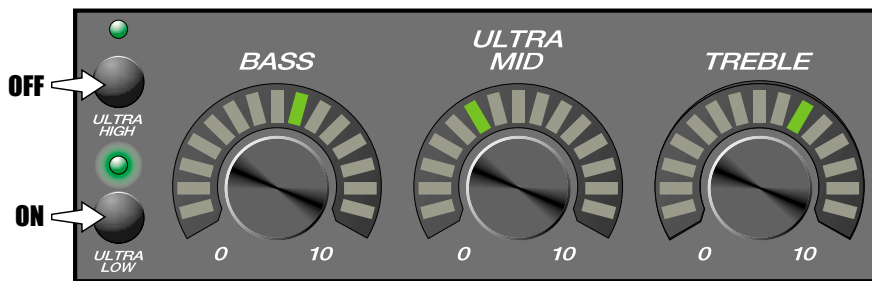

FUNK "POPPING:"

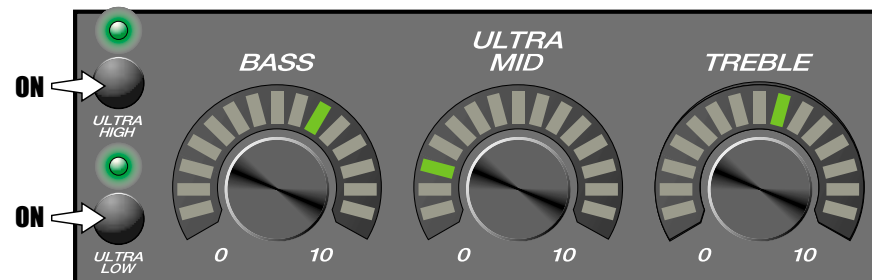

Rack Mounting

When mounting the amplifier into a rack, the four bottom feet should be removed to maintain the two rack space height of the amplifier. Be sure to keep the feet and their attachment bolts for future use. If the feet are reinstalled, never use screws which will protrude farther into the amplifier than the original hardware.

The rack must be a high quality enclosure capable of securely supporting the weight of the amplifier. Tighten the mounting screws securely through the amplifier's face plate, into the rack rails. Check the rack and mounting screws occasionally to ensure a continual safe and secure installation.

Presets:

The B500DR has four presets which may be selected by the front panel Presets switches (#11) **or** by the AFP4D four button footswitch. When the B500DR is powered up, it defaults to Preset 1 - the controls will reset themselves to that Preset and the LEDs will change accordingly to indicate Preset 1's settings. The LED adjacent to the Preset 1 switch illuminates accordingly. When a footswitch is used, the LED adjacent to the footswitch pushbutton illuminates brighter than the other three LEDs - a feature performing musicians will find very useful when playing in darkened venues.

Programming the B500DR:

To program one of your settings into one of the presets, adjust the front panel controls to the desired setting. Depress and hold the desired Preset switch (1 through 4) until the LEDs adjacent to the Preset switches flash. Your new setting is now stored as a preset. The LEDs will stop flashing after approximately 1-2 seconds. The LED adjacent to the programmed Preset switch will remain illuminated.

When you manually change the position of one of the controls, the LEDs around the affected control flashes to show that the setting has been changed. The LEDs stop flashing when you either program the new setting into a Preset, select a different Preset, or return the control to its original position for the selected Preset.

The front panel Preset switches and the footswitch may be used concurrently. The LEDs on the front panel and on the footswitch indicate which Preset is active regardless of how the Preset was selected (by the front panel switches or by the footswitch).

Troubleshooting

In the unlikely event that your B500DR should malfunction, take a few minutes to troubleshoot it before you call for service. You can save yourself time and money by doing it yourself, and often the problem is something quite simple.

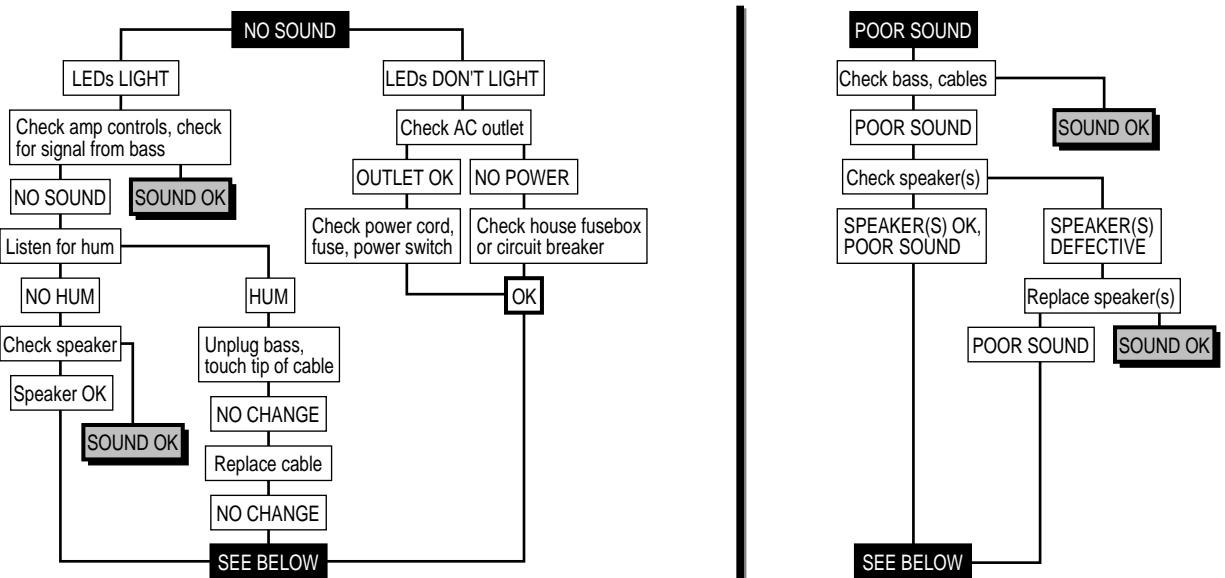

If the problem isn't covered above, or if the steps lead you here, then contact your Ampeg dealer for service information. Also, you should refer your amp to an authorized service center if it gets dropped, has liquid spilled into it, or sustains damage to its power cord.



Ampeg B500DR Programmable Bass Amplifier

Technical Specifications

OUTPUT POWER RATING	500 Watts @ 2 Ohms 350 Watts @ 4 Ohms
TONE CONTROL RANGE	Bass: 16dB range @ 50Hz Ultra Mid: +6dB @ 600Hz, -9dB @ 350Hz Treble: 31dB range @ 5kHz Ultra High: +8dB @ 10kHz Ultra Low: +7dB @ 40Hz
SIGNAL TO NOISE RATIO	75dB typical
POWER REQUIREMENTS	120VAC, 60Hz, 545VA 100-120VAC 50/60Hz, 545VA 220-240VAC, 50/60Hz, 545VA
SIZE AND WEIGHT	19"W x 3.8"H (with feet) x 15.5"D; 32 lbs

System Block Diagram

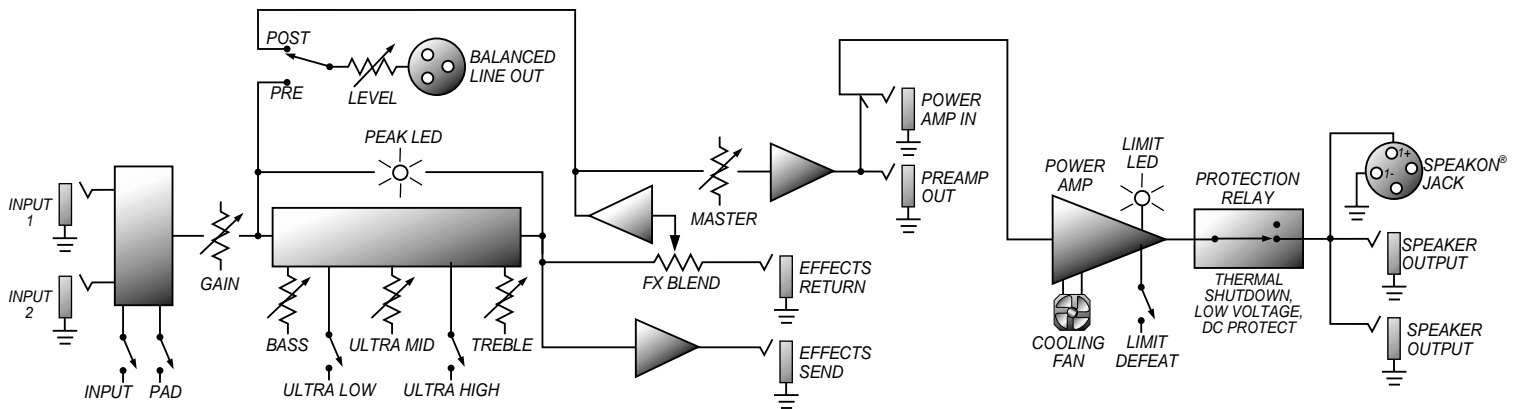

Ampeg reserves the right to change specifications without notice.

Declaration of Conformity

Manufacturer's Name: SLM Electronics
Corporate Headquarters: 1901 Congressional Drive, St. Louis, Missouri 63146
Primary Production Facility: 700 Hwy 202 W, Yellville, Arkansas, 72687

Product Type: Audio Amplifier

Products meet the regulations for compliance marking under:

ETL standards UL6500, UL60065, or UL813
 CSA standards E60065 or C22.2 No.1-M90
 CE safety standard EN60065
 CE EMC standards EN55103 or EN55013 and EN61000
 FCC standards 47CFR 15.107 and 15.109 Class A
 C-tick designation Level 2, ABN #56748810738, ARBN# N222
 KETI standard K60065 (limited model approval)

Compliance Support Contact: SLM Electronics, Attn: R&D Compliance Engineer
 1901 Congressional Drive, St Louis, Missouri, 63146 • Tel.: 314-569-0141, Fax: 314-569-0175



Made with Pride in the U.S.A. by Ampeg • ©2004 Ampeg, 1400 Ferguson Avenue, St. Louis, MO 63133 U.S.A.

P/N 47-697-01 • 073004

