

Owner's Guide
for the
Ampeg

VL-503
Guitar Amplifier

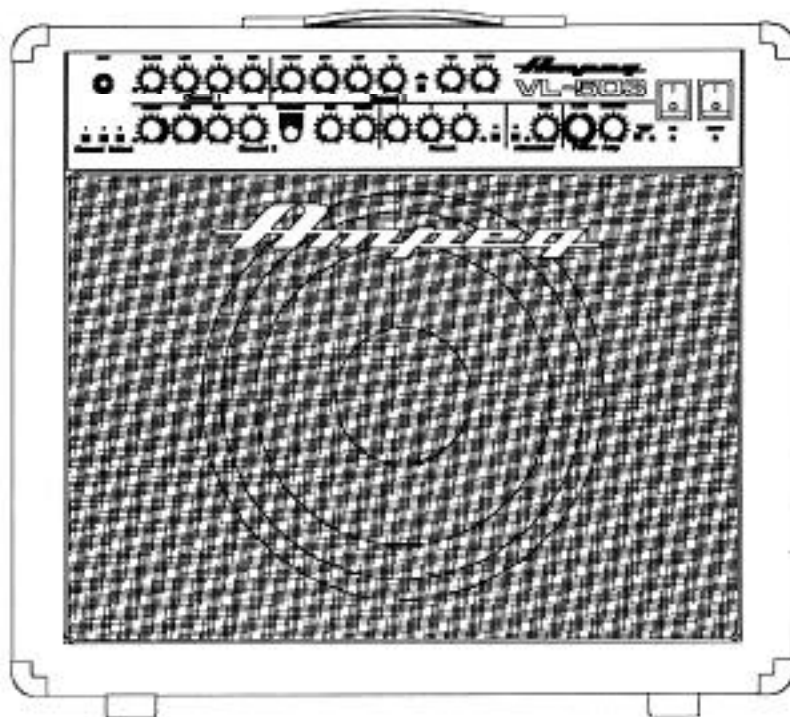

Made in the
U.S.A.

by

Ampeg

An Introduction To Your New Ampeg VL-503 Guitar Amplifier

First of all, **thank you** for making what could be one of the best choices you could ever make concerning your musical career - choosing one of the finest guitar amplifiers available, the Ampeg VL-503.

Your VL-503 amplifier has all the power and flexibility you'll need, plus some pretty outstanding features designed to set you apart from the other guys. (You know the ones: they're satisfied with the same level of performance you grew tired of about a year ago!)

All of the features and controls of your VL-503 are covered in detail within the pages of this owner's guide. Go over them before you get started with the amp - to get the most out of it, put a little time into it. It'll be worth it.

TABLE OF CONTENTS

Features	3
Important Safeguards and Precautions	3
The Front Panel Controls and Their Use	4-5
The Rear Panel	6-7
Changing the Preamp/Power Amp Tubes	8
Setting the Bias Switch	8
Adjusting the Hum Balance	8
Adjusting Tube Bias	9
Output Tube Failure	9
Line Out Operation	9
Recording Out Operation	9
Effects Loop Operation	9
Some Suggested Settings	10
Troubleshooting	11
System Block Diagram	11
Technical Specifications	back cover



CAUTION

RISK OF ELECTRICAL SHOCK.
DO NOT OPEN.



CAUTION: TO REDUCE THE RISK OF ELECTRICAL SHOCK, DO NOT REMOVE COVER. NO USER-SERVICEABLE PARTS INSIDE. REFER SERVICING TO QUALIFIED SERVICE PERSONNEL.



ATTENTION

RISQUE D'ELECTROCUTION.
NE PAS OUVRIRE.



ATTENTION: POUR REDUIRE LES RISQUES D'ELECTROCUTION NE PAS OUVRIRE LE COUVERCLE. AUCUNE PIECE INTERIEURE N'EST REPARABLE PAR L'UTILISATEUR. POUR TOUTE REPARATION, S'ADRESSER A UN TECHNICIEN QUALIFIE.



VORSICHT

ERSTESCHNUNGSSCHLAGGEFAHR.
NICHT OEFFNEN.



VORSICHT: ZUR VERMEIDUNG ELEKTROISCHER SCHLAGGEFAHR NICHT DEN DECKEL ABNEHMEN. KEINE TEILE KONNEN NICHT VOM BENUTZER GEWARTET WERDEN. DIE REPARATUR IST QUALIFIZIERTEM WARTUNGSPERSONAL ZU UBERLASSEN.

THIS EQUIPMENT HAS BEEN DESIGNED AND ENGINEERED TO PROVIDE YEARS OF SAFE AND RELIABLE OPERATION. IN ORDER TO PROLONG THE LIFE OF THE UNIT AND PREVENT ACCIDENTAL DAMAGES OR INJURY, PLEASE FOLLOW THESE PRECAUTIONARY GUIDELINES.

WARNING: TO REDUCE THE RISK OF ELECTRIC SHOCK:

- (1) DO NOT OPEN CHASSIS.
- (2) DO NOT DEFEAT OR REMOVE THE GROUND PIN OF THE POWER CORD; CONNECT ONLY TO A PROPERLY GROUNDED AC POWER OUTLET.

CAUTION: TO REDUCE THE RISK OF FIRE OR ELECTRIC SHOCK, DO NOT EXPOSE THIS EQUIPMENT TO RAIN OR MOISTURE.

CAUTION: NO USER SERVICEABLE PARTS INSIDE. REFER SERVICING TO QUALIFIED SERVICE PERSONNEL.

CAUTION: OUR AMPLIFIERS ARE CAPABLE OF PRODUCING HIGH SOUND PRESSURE LEVELS. CONTINUED EXPOSURE TO HIGH SOUND PRESSURE LEVELS CAN CAUSE PERMANENT HEARING IMPAIRMENT OR LOSS. USER CAUTION IS ADVISED AND EAR PROTECTION IS RECOMMENDED IF UNIT IS OPERATED AT HIGH VOLUME.

EXPLANATION OF GRAPHICAL SYMBOLS:



"DANGEROUS VOLTAGE"
"DANGER HAUTE TENSION"
"GEFAHRHOHE SPANNUNG"



"IF IS NECESSARY FOR THE USER TO REFER TO THE INSTRUCTION MANUAL"
"REFEREZ-VOUS AUMANUEL D'UTILISATION"
"UNBEDINGT IN DER BEDIENUNGSANLEITUNG NACHSCHLAESSEN"

Features

"VL" stands for one thing: **"VERY LOUD."** In fact, the VL-503 gives you more gain (without noise) than *ANY* stock amplifier on the market! But this amp doesn't stop there. Below are some of the features that come with all that "LOUD". Additional information on certain features can be found on the pages indicated.

- **THREE TOTALLY DISCRETE CHANNELS:** Not just three sound settings, but more like three amplifiers in one: pull the tubes out of one channel and the others still keep going. Try doing that on another brand of stage amp. (On second thought, DON'T!)
- **SEPARATE CHANNEL CONTROLS:** Preamp, Tone, and Reverb controls for each channel, for ultimate flexibility and control over your sound. (page 4-5)
- **ADJUSTABLE POWER ATTENUATOR:** Want all of the compression, distortion, and fire of a live performance, without the high volume? Hit the Power Attenuator button and dial in the level that fits your environment, without sacrificing tone quality. (page 5)
- **SELECTABLE MID FREQUENCY:** Choose from five settings for the midrange point on Channel III, for just the right sound, or perhaps a new one. (page 5)
- **ADJUSTABLE PRESENCE CONTROL:** Fully adjustable upper harmonics level for changing the "presence" of all the channels. (page 5)
- **SLOPE CONTROL:** When turned clockwise, the Slope control decreases damping and boosts highs. Counterclockwise, damping is increased and bottom end is boosted.
- **6550/EL34 BIAS SWITCH:** Want to change your sound? Change your tubes! Then adjust the amp's bias with just the flick of a switch. (page 6)
- **ACTIVE EFFECTS LOOP:** Lets you add another stage of gain to the effects loop, giving you even more control over your sound. Access to multiple amplifiers is also available through this loop. (page 7)
- **FOOTSWITCH:** Lets you change channels, turn on the Effects Loop and Reverb with the touch-sensitive buttons on the supplied switch box.

Important Safeguards and Precautions

All Ampeg products are designed for continued safe operation, as long as common sense is followed and steps are taken to help avoid certain problems. Abiding by the following rules can help prevent damage to your amplifier, yourself, and others.

- The amp is equipped with a three-prong AC power cord. To reduce the risk of electrical shock, **NEVER** remove or otherwise attempt to defeat the ground pin of the power cord.
- Connect the amplifier **ONLY** to a properly grounded AC outlet of the proper voltage for your amp. If no grounded outlet is available, use **ONLY** an approved method of adapting to a two-prong AC source.
- Avoid sudden temperature extremes, rain, and excessive moisture. Also, avoid sudden and intense impact. (If the unit has been subjected to any of the preceding abuses, have it looked at by an authorized service center. See page 11).
- The amplifier is heavy: never set it up on a support that might give out under its weight.
- Unplug the amp before cleaning it. Never spray liquid cleaners onto the amp: wipe it with a slightly dampened, lint-free cloth to remove dirt and film.
- Don't use the amplifier if it has sustained damage to the cabinet, controls, or power cord. Refer the unit to an authorized service center for inspection. (See page 11).
- Amplifiers capable of producing high volume levels are also capable of inflicting permanent hearing loss or damage, if the exposure to such levels is prolonged. Such damage is progressive and irreversible! Caution is advised and ear protection is recommended when playing at extremely loud levels.

The chart below shows the U.S. Government Occupational Safety and Health Administration (OSHA) regulations for permissible noise exposure, per 29CFR1910.95, table G-16.

SOUND LEVEL dBA, SLOW RESPONSE	DURATION PER DAY IN HOURS
90	8
92	6
95	4
97	3
100	2
102	1-1/2
105	1
110	1/2
115	1/4 or less

According to OSHA, any exposure in excess of those listed above could result in some hearing loss.

The VL-503 Front Panel

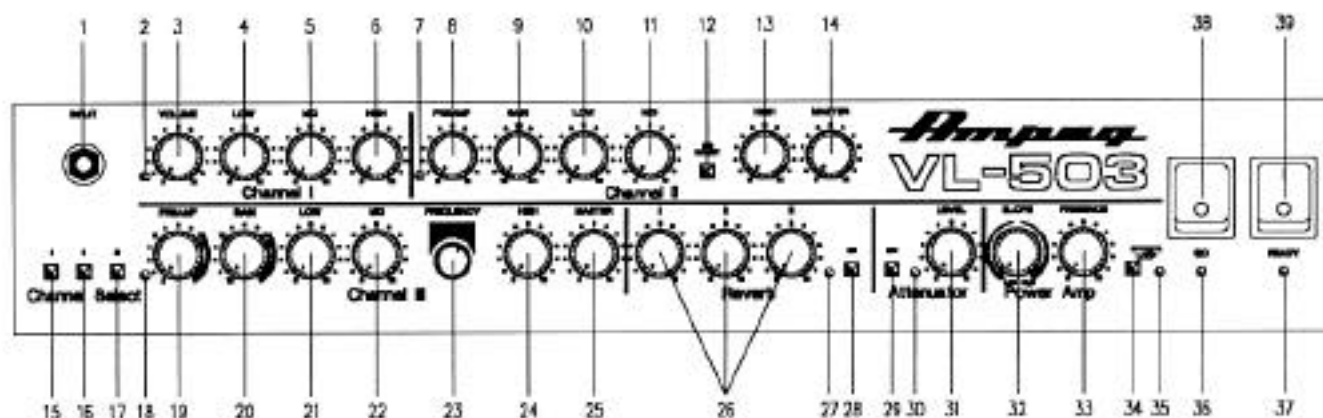

1) **INPUT:** Connect your guitar or wireless receiver into this standard 1/4" jack using a shielded instrument cable.

CHANNEL I CONTROLS

2) **INDICATOR LED:** This LED glows red when the amp is set to Channel I.

3) **VOLUME:** The volume control for Channel I. Turned all the way to the left, no signal passes through to the preamp. Turn it up a little and you get a clean signal; turn it up a lot and get a loud clean signal.

4) **LOW:** The bass control: allows for 15dB of cut (full left) or boost (full right) at 40Hz. The center position is considered "flat".

5) **MID:** The midrange control: allows for 12dB of cut (full left) or boost (full right) at 316Hz; center position is "flat".

6) **HIGH:** The treble control: allows for 16dB of cut (full left) or boost (full right) at 5kHz; center position is "flat".

CHANNEL II CONTROLS

7) **INDICATOR LED:** This LED glows red when the amp is set to Channel II.

8) **PREAMP:** Use as an input pad for Channel II. Turned all the way to the left, no signal passes through to the preamp. Turn it up a little and you get a slightly overdriven signal; turn it up a lot and you'll get lots of

distortion - with plenty of in-betweens. Use this control along with the Channel II Gain and Master (#9 & 14) to get the sounds you're after. (Some suggested settings are on page 10).

9) **GAIN:** Use this control to vary the distortion: with the control all the way to the left there isn't any gain added to the signal; as you bring the control towards center, the amount of distortion increases (and so does the output volume). Keep turning to the right and you'll increase distortion and the output volume even more. As you near the full right position, you'll not only boost the gain, but you'll add even more tube compression.

10) **LOW:** The bass control: allows for 10dB of cut (full left) or boost (full right) at 40Hz. The center position is considered "flat".

11) **MID:** The midrange control: allows for 14dB of cut (full left) or boost (full right) at 750Hz; center position is "flat".

12) **MID BOOST:** This switch, when pressed in, lowers the center frequency of the treble control; allowing an increase in midrange presence.

13) **HIGH:** The treble control: allows for 5dB of cut (full left) at 250Hz or boost (full right) at 5kHz; center position is "flat".

14) **MASTER:** Adjust the output level for Channel II with this control: turned all the way to the left, no signal passes to the power amp. As you rotate the control to the right, the output increases. Use this control along with Channel II's Preamp and Gain controls for a wide variety of sounds. (See "Some Suggested Settings on page 10 for more info).

15) **CHANNEL I SELECTOR SWITCH:** This switch sets the amp to Channel I.

16) **CHANNEL II SELECTOR SWITCH:** This switch sets the amp to Channel II.

17) **CHANNEL III SELECTOR SWITCH:** This switch sets the amp to Channel III.

CHANNEL III CONTROLS

7) **INDICATOR LED:** This LED glows red when the amp is set to Channel III.

8) **PREAMP:** Use as an input pad for Channel III. Turned all the way to the left, no signal passes through to the preamp. Turn it up a little and you get a slightly overdriven signal; turn it up a lot and you'll get lots of distortion - with plenty of in-betweens. Use this control along with the Channel III Gain and Master (#20 & 25) to get the sounds you're after. (Some suggested settings are on page 10).

20) **GAIN:** Use this control to vary the distortion: with the control all the

of distortion increases (and so does the output volume). Keep turning to the right and you'll increase distortion and the output volume even more. As you near the full right position, you'll not only boost the gain, but you'll add even more tube compression.

21) LOW: The bass control: allows for 10dB of cut (full left) or boost (full right) at 40Hz. The center position is considered "flat".

22) MID: The midrange control: allows for 14dB of cut (full left) or boost (full right) at 750Hz; center position is "flat".

23) FREQUENCY: Select Channel III's treble center frequency by the setting of this five-way switch. Rotating the switch to the left (1) raises the center frequency of the treble control; giving a brighter, more crisp tone. Conversely, rotating the switch to the right (5) lowers the center frequency of the treble control, which in turn adds mids and thickens the sound. A standard setting for high gain humbucking pickups is 1 or 2, and single coil pickups are better suited to a setting of 4 or 5. Of course, the best setting for you is the one which gives you the sound you like most.

24) HIGH: The treble control: allows for 5dB of cut (full left) at 250Hz or boost (full right) at 5kHz; center position is "flat".

25) MASTER: Adjust the output level for Channel III with this control: turned all the way to the left, no signal passes to the power amp. As you rotate the control to the right, the output increases. Use this control along with Channel III's Preamp and Gain controls for a wide variety of sounds. (See "Some Suggested Settings" on page 10 for more info).

REVERB SECTION

26) REVERB I, II, & III: Set the amount of reverberation for each channel by adjusting its corresponding Reverb control: turned all the way to the left, the signal is dry (no reverb); rotate the control towards the right to

increase the level of reverb effect. The AFP-5 footswitch offers remote Reverb On/Reverb Off for all three channels (see #61, page 7).

27) REVERB "ON" LED: This LED glows green when the reverb is on.

28) REVERB SWITCH: This switch turns the reverb ON for all three channels. It can be overridden by the Reverb footswitch (see #61, page 7).

POWER ATTENUATOR SECTION

29) ON/OFF SWITCH: When pressed, this switch activates the amplifier's "Output Level Limiter" feature, allowing you to reduce the output volume from the amp without losing the compression and distortion of high-volume settings. Adjustment of sound is between Channel Volume and Power Attenuator Level control.

30) ON LED: This LED glows yellow when you engage the Power Attenuator, giving you instant verification that the Attenuator is active.

31) LEVEL: This control allows you to adjust the output signal level when the Power Attenuator is engaged. Turned all the way to the left, the output signal is cut completely. As you bring the control toward the right, the output level increases - at the full right position (12) the output level is at full power, as if the Attenuator wasn't engaged.

POWER AMP SECTION

32) SLOPE: This control, when turned to the left, increases the damping and accentuates the lower (bass) frequencies. As it is turned to the right, it uses less damping and accentuates the higher (treble) frequencies.

33) PRESENCE: This is the upper harmonics control for all three channels, providing an additional 10dB of boost at 7kHz to the setting of the High controls.

EFFECTS LOOP SECTION

34) ON/OFF SWITCH: This switch engages the Effects Loop (see #58-60, page 7) on the rear panel. The signal will be routed out through the Send jack (#60, page 7) and into your effects device for processing.

35) ON LED: This LED will glow yellow when the Effects Loop has been activated.

36) GO LED: The "ready to play" indicator: glows green when you throw the GO switch (#38) to the ON (up) position. Lets you know at a glance that the amp is completely turned on.

37) READY LED: The "power on" indicator: glows red when you turn the READY switch (#39) ON (up). Lets you know that the AC line power has been turned on and the amp is ready to go.

38) GO SWITCH: The "ready to play" switch. Applies voltage to the tubes when thrown to its ON (up) position.

NOTE: When you first turn the amp on, leave the Go switch OFF for at least ten seconds - this gives the tubes a chance to warm up before the juice hits them.

39) READY SWITCH: The "power on" switch. Applies AC voltage to the amp when thrown to the ON (up) position.

NOTE: Always turn the Ready switch ON FIRST, OFF LAST. See the note under #38 for additional information.

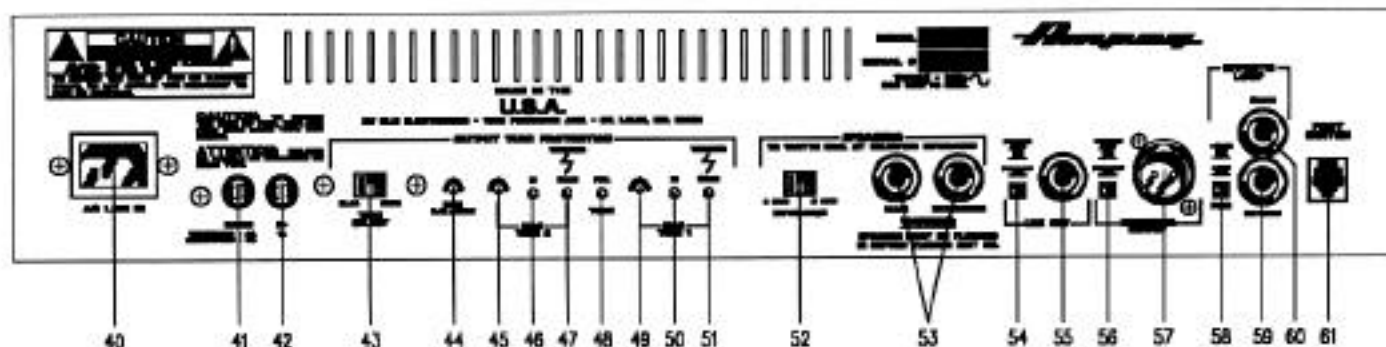

40) AC LINE CORD RECEPTACLE:

Firmly plug the female end of the supplied power cord into this socket, pushing it in until it is fully seated. Plug the male end of the cord into a grounded AC outlet. **DO NOT DEFEAT THE GROUND PIN OF THE AC PLUG!** Use only the supplied power cord. If you travel to areas outside the United States, see your Ampeg dealer for information about power converters, and alternate line cord plugs if needed.

41) MAINS FUSE: Protects the amplifier against damages caused by overload conditions in the AC line source. If the fuse blows, replace it only with the same size and type as indicated on the rear panel. If the amp does not come on after replacing the Mains Fuse, the internal fuse may be at fault. Refer to a qualified service technician for replacement.

NOTE: If the fuse continually blows, the line voltage may be incorrect, or the amplifier might need servicing. See "Troubleshooting" on page 11.

42) B+ FUSE: Protects the output tubes from overload conditions and/or other damage. If the fuse blows, replace it only with the same size and type as indicated on the rear panel.

NOTE: If the fuse continually blows, you may have an output tube problem. Refer to page 9.

OUTPUT TUBE PROTECTION

43) BIAS SELECT SWITCH: Allows for instant bias adjustment when changing the output tube types, with your choice of the American "Heavy Metal" sounding 6E50s or the European "British Rock" sounding EL-34s. **BE SURE TO ALWAYS KEEP THIS SWITCH AT THE PROPER SETTING.** See "Setting the Bias Switch" on page 8 for more information.

44) HUM BALANCE: Allows for reduction of residual hum, especially after changing power tubes. See "Adjusting the Hum Balance" on page 8 for more information.

45) TUBE 2 BIAS ADJUSTMENT: Sets the bias for the output tube(s). See "Adjusting Tube Bias" on page 9 for more information.

46) TUBE 2 "IN BIAS" LED: Glows green when the output tube(s) are in bias. See "Adjusting Tube Bias" on page 9 for more information.

47) TUBE 2 "OVER BIAS" LED: Glows red when the output tubes are over biased. See "Adjusting Tube Bias" on page 9 for more information.

48) OUTPUT TUBE FAILURE LED: Glows red when output tube(s)

failure has occurred. See "Changing the Preamp/ Power Amp Tubes" on page 8, and "Output Tube Failure" on page 9 for more information.

49) TUBE 1 BIAS ADJUSTMENT: Same as #45.

50) TUBE 1 "IN BIAS" LED: Same as #46.

51) TUBE 1 "OVER BIAS" LED: Same as #47.

SPEAKER SECTION

52) IMPEDANCE SELECT: You **MUST** match the impedance of your amplifier to any speakers you may connect to the amplifier!!! And with this selector switch and the chart below, **you can!** Use a screwdriver blade to switch to the proper setting for your setup. The total impedance of various combinations of cabinets wired in parallel are as follows:

Cabinet Impedance	# of Cabinets	Set Imp. Switch to:
4 ohms	1	4 ohms
8 ohms	1	8 ohms
8 ohms	2	4 ohms
16 ohms	2	8 ohms
16 ohms	4	4 ohms

A VERY IMPORTANT NOTE:

Always set the Impedance Selector switch to the same or higher impedance as the cabinet(s). Setting the switch to a lower impedance will cause unnecessary and harmful strain of the amplifier's output transformer!

53) SPEAKERS: Use these paralleled 1/4" unbalanced jacks to connect the output of your amplifier to additional speakers. Use heavy gauge speaker cables for this, **NOT** instrument patch cords.

LINE OUT SECTION

54) LINE OUT SWITCH: The signal can be set to be sent from either the preamp or the power amp by the Line Out switch.

55) LINE OUT JACK: This unbalanced 1/4" jack supplies an output signal for connecting to a house mixing board, recording console, or external amplifier(s) or effects.

RECORDING OUTPUT SECTION

56) RECORDING OUTPUT SWITCH: The signal can be set to be sent from either the preamp or the power amp by the Recording Output switch.

57) RECORDING OUTPUT JACK: This balanced XLR jack supplies an output signal for connecting to a house mixing board, recording console, or external amplifier(s).

EFFECTS LOOP SECTION

58) PAD: The Effects Loop Send jack is padded and the Return is boosted by 14dB when you lock this switch in its -10dB (in) position. This keeps the Effects Loop signal at a useable level at all volumes and ensures a proper signal match with any and all effects. Rack-mounted effects usually like it better without the boost (+4dB position); floor pedals like it better WITH the boost (switch IN). Of course, how you like it is entirely up to you!

59) RETURN: Connects to the output jack of an external effects device, tapping into the power amp just prior to the reverb circuits.

60) SEND: Connects to the input of your external effects device to provide it with your guitar's signal for processing. The Send jack can also

be used to provide a preamped signal out to an external mixing board, PA system or amplifier.

Connecting your effects devices through the Effects Loop reduces noise and allows you to take advantage of an additional tube gain stage. Even if you aren't using any effects, pressing the Effects Loop on/off switch (#34, page 5) adds an additional 12dB of gain to your signal, giving you increased compression and distortion, with or without any effects.

61) FOOTSWITCH: Connect the Ampeg AFP-5 footswitch controller here, with the modular plug, to give you remote control over Channel selection, the Effects Loop, and Reverb on/off.

The illustrations below show examples of connecting the amplifier to an external effect.

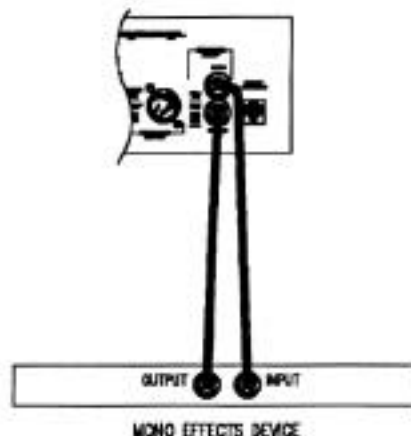
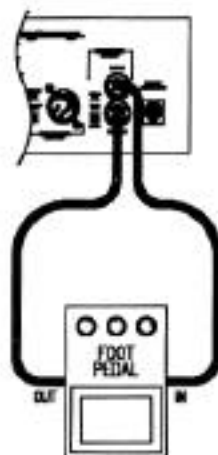

Changing the Preamp/ Power Amp Tubes

Vacuum tubes are only human - they can only last so long. Allowing your amp to cool down before moving it will help prolong the life of the tubes. Even so, after about a year (or sooner if you're on tour or jammin' more frequently than most) you may notice the output of your amp just isn't as "alive" as it used to be, indicating preamp tubes may be bad. If the amp starts to squeal, gets noisy, loses gain or starts to hum, the preamp tubes may be bad. Or, perhaps you want to try out the other type of power tube to change your sound: 6550s tend to give you more of the "American" sound, with lots of clean power, even up to their full output, with a lot of dynamic headroom. They're great heavy-metal players' tubes. EL-34s tend to give you that "English/British" sound: they run hotter than 6550s, distort sooner and provide a more controllable and less penetrating distortion effect when overdriven. These tubes are better suited for more traditional rockers, jazz and R&B players. Either way, your VL-503 has been designed to facilitate easy tube replacement, with instant biasing available when changing power tube types. **IF YOU DON'T CONSIDER YOURSELF ADEPT WITH A SCREWDRIVER, REFER TUBE REPLACEMENT TO A QUALIFIED SERVICE CENTER.** Otherwise, unplug your amp, allow it to cool for about ten minutes, and proceed as follows:

POWER AMP TUBE REPLACEMENT

- Turn the amp so you are looking at the rear.
- Unscrew and remove the wooden tube shield and set aside.
- Remove the tube retainers from the tubes.
- Carefully pull out the old tubes and dispose of them properly.
- Line up the pins of the new tubes with their sockets and gently but firmly insert them.
- Replace the tube retainers and wooden tube shield.

Since the power tubes work harder in an amplifier than the preamp tubes, they're almost always the first to go. If the sound from your amplifier starts to grow weak, lacks punch, fades up and down, loses highs and lows, or gets "funny" (clanking sounds, etc.), it's very likely that the power tubes are worn out and need replacing. Since power tubes work together in the amplifier, it is important that they all be replaced at the same time with a matched set of the same type of tube.

If your amplifier squeals, gets noisy, loses gain, starts to hum, lacks "sensitivity to touch" or feels like its working against you, the preamp tubes may need replacing. Remember to only use good quality, low-microphonic tubes in the preamp section. **BECAUSE YOUR PREAMP TUBES ARE LOCATED INSIDE OF YOUR VL-503 CHASSIS, REFER PREAMP TUBE REPLACEMENT TO A QUALIFIED SERVICE CENTER.**

VERY IMPORTANT: YOU MUST BREAK IN NEW POWER TUBES!

Turn the Ready and Go switches **OFF** and plug in the amp. **Leave the Go switch OFF and turn on the Ready switch ONLY.** now go away; let the amp sit for at least **five minutes**, **then** you can turn Go on and play again!

Setting the Bias Switch

The Bias switch **will not** in itself change the sound of your amp: you can't make 6550 tubes sound like EL-34s just by moving the switch! The only time you'll ever have to move this switch is after changing the power tubes from one TYPE to the other; you'll have to reset the system bias to accommodate the new tubes.

To change the setting of the Bias switch, remove one of the screws which hold the switch cover in place, and loosen the other one. Rotate the cover out of the way and use the tip of a key or small screwdriver to slide the switch to its new position. Replace the cover and screw it down. Biasing is complete!

Adjusting the Hum Balance

If you notice a high amount of residual hum coming from your amplifier (especially after changing preamp tubes), slowly turn the Hum Balance pot (#44 on the rear panel) until the hum is at a minimum. Use a small blade screwdriver or TV adjustment tool for this.

Adjusting Tube Bias

Your amplifier has individual bias matching controls. By adjusting your bias control, you can match your tubes for best results.

First, turn your amp on (Ready). Let the amp warm up for a couple of minutes. Now, turn on the Go switch and make sure the speaker is plugged in (*Do not plug in your instrument or play through the amp while doing this setup*). Let the amp now warm up for another five minutes. Using a small screwdriver, adjust each bias control until the green light illuminates. Do not leave the amp with the red light(s) on for more than a minute. It is not uncommon for tubes to age or settle over a couple of months, so readjust if the green lights are not on.

NOTE: LIGHTS WILL BLINK FROM GREEN TO RED WHILE YOU PLAY - THIS IS NORMAL.

Output Tube Failure

When an output tube failure occurs, the amplifier automatically shuts down, blows the B+ Fuse, and the red LED stays on until the tube(s) and fuse are replaced. This protects the rest of your amplifier from extreme damage that generally occurs when output tubes fail.

Line Out Operation

Preamp Setting

The signal for this is tapped off post-Effects Loop and Reverb and pre-power amp.

Power Amp Setting

The signal for this is tapped off of the Speaker jack. The level is reduced through a resistive divider which makes the level manageable. The amplifier must have a load on it at all times, even when you are using the Line Out as a preamp out.

Recording Out Operation

The signal here is tapped off post-Effects Loop and Reverb and pre-power amp. After each point that is tapped, it goes through a speaker component which gives the sound of a 4/12 speaker cabinet, then an active direct box.

Ampex

VL-503

Some Suggested Settings

'74 Silver Face Twin '66 JTM 45

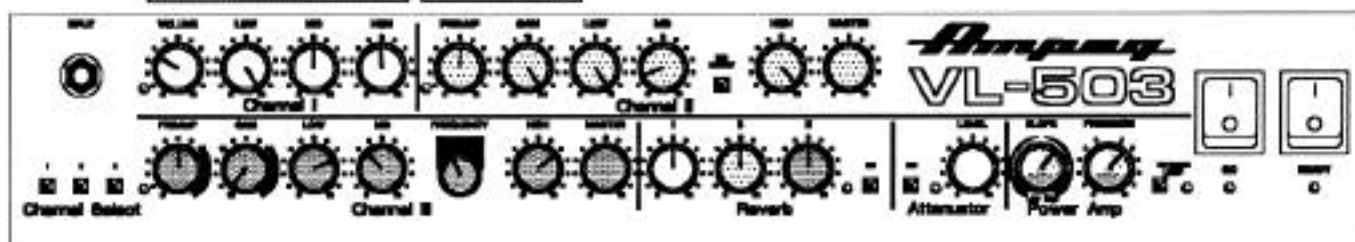

'73 100 Watt Super Lead

'55 Champ With Attenuator '61 Tan AC30

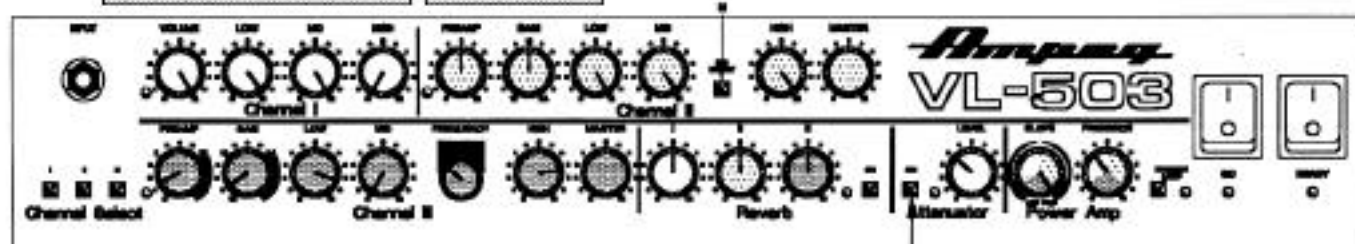

'65 AC30 Top Boost

'64 ReverbRocket '77 Boogie Mark 1

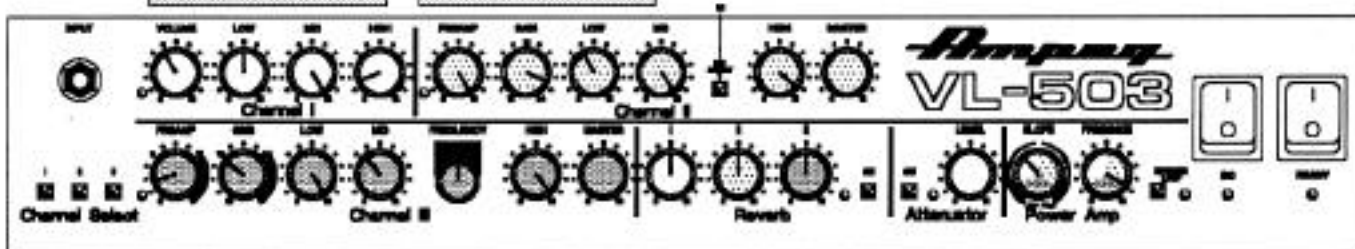

'71 HiWatt Custom 50

'64 Black Face Twin '62 Brown Face Deluxe

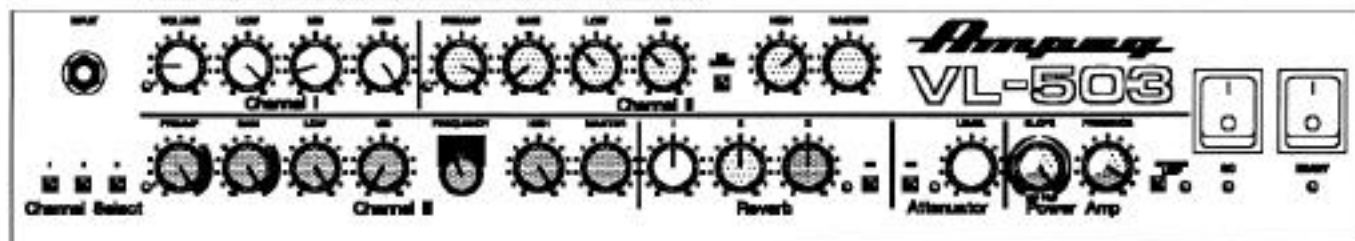

'60s Fuzz Face

Troubleshooting

In the event that your VL-503 should stop working properly, or just stop working, take a few minutes to troubleshoot it before you call for service. You can save yourself a lot of time and sometimes money by doing it yourself, and often the cure for the problem is something quite simple.

If the problem isn't covered in the chart, or if the steps listed above led you here, then contact your Ampeg dealer for the name of the authorized service center nearest you. **Never** let anyone else mess with your amp! Aside from possibly destroying it for you, they'll void your warranty.

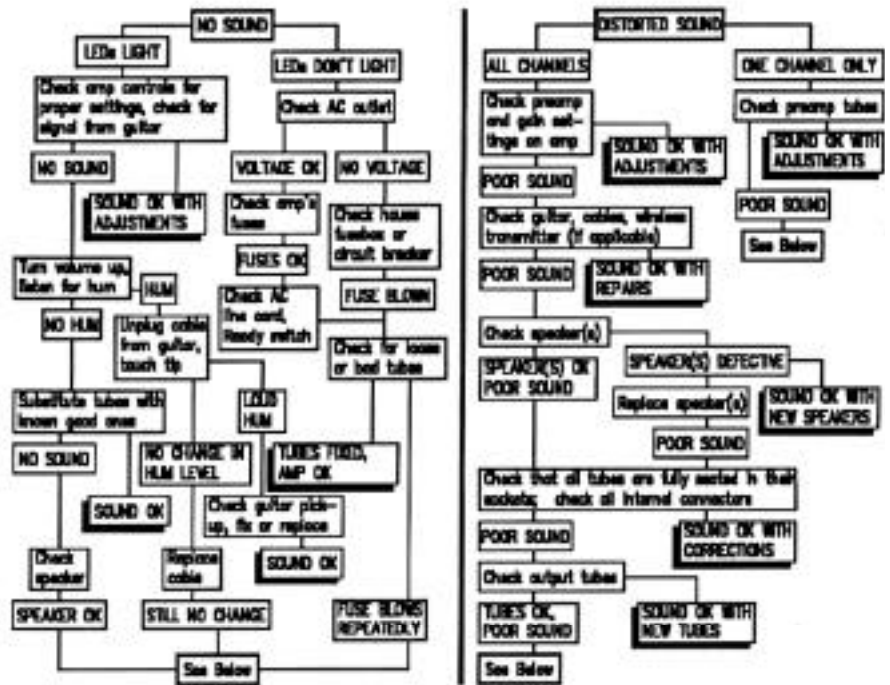

System Block Diagram

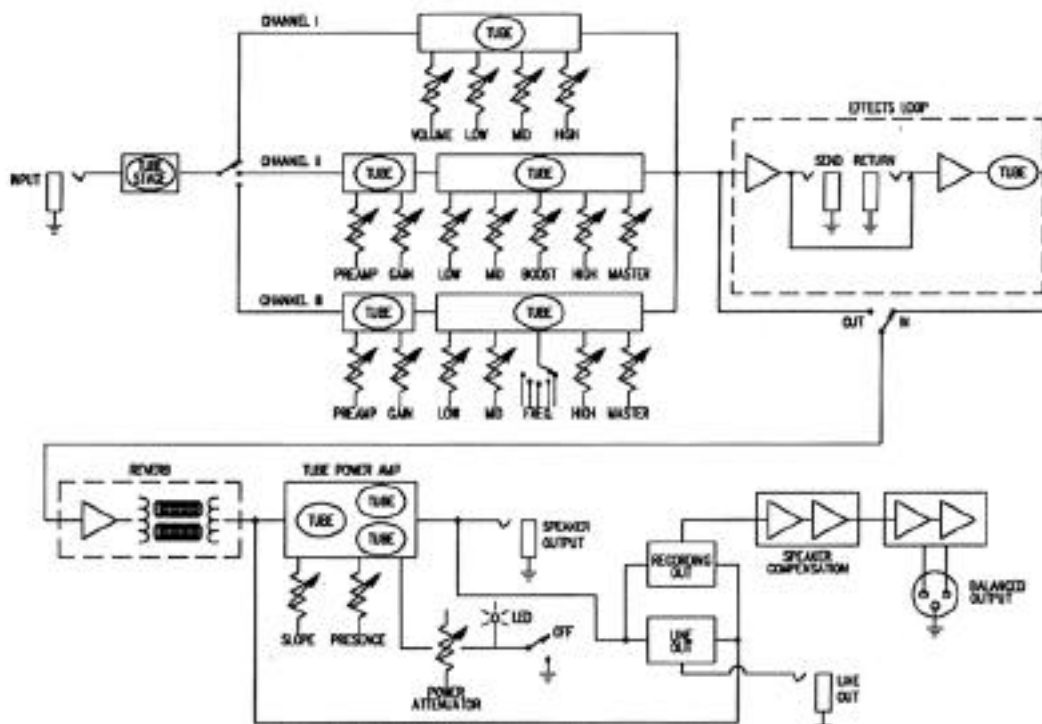



VL-503

Technical Specifications

OUTPUT POWER RATING	50 watts/channel min. RMS @ 5% THD
TONE CONTROL RANGE	
CHANNEL I	
LOW	15dB @ 40Hz
MID	12dB @ 316Hz
HIGH	16dB @ 5kHz
CHANNEL II	
LOW	10dB @ 750Hz
MID	14dB @ 750Hz
MID BOOST	+5dB @ 1kHz
HIGH	-5dB @ 250Hz, +5dB @ 5kHz
CHANNEL III	
LOW	10dB @ 750Hz
MID	14dB @ 750Hz
HIGH	-5dB @ 250Hz, +5dB @ 5kHz
PRESENCE	10dB @ 7kHz
INPUT IMPEDANCE	1m-ohm
POWER REQUIREMENTS	4A, 120VAC, 60Hz
FUSES	
MAINS	5A Slo-Blo
B+	1A Slo-Blo
SIZE AND WEIGHT	21.6875" W x 19.75" H x 11.5" D 85 lbs.

Ampeg reserves the right to change specifications without notice.



recyclable

Ampeg is proudly Made in America. A product of SLM Electronics, 1400 Ferguson Ave., St. Louis, MO. 63133, U.S.A.
P/N 47-404-01