

Ampeg

SCRAMBLER

Bass Overdrive

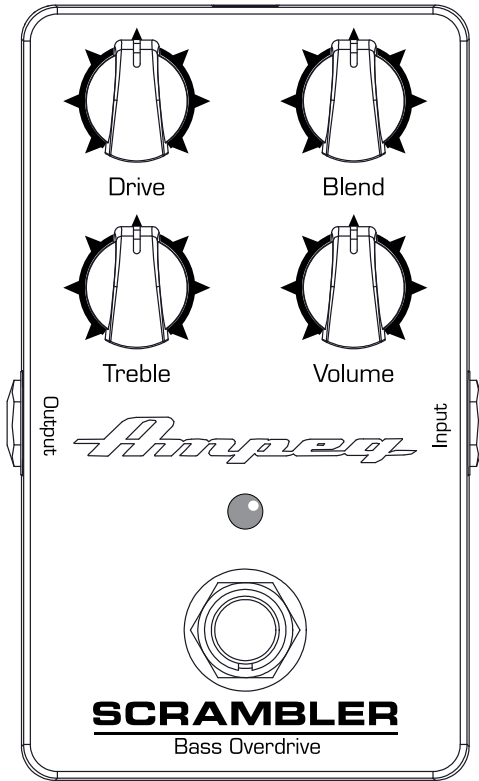

Owner's Manual



IMPORTANT SAFETY INSTRUCTIONS

1. Read these instructions.
2. Keep these instructions.
3. Heed all warnings.
4. Follow all instructions.
5. Do not use this apparatus near water.
6. Clean only with a dry cloth.
7. Do not block any ventilation openings. Install in accordance with the manufacturer's instructions.
8. Do not install near any heat sources such as radiators, heat registers, stoves, or other apparatus (including amplifiers) that produce heat.
9. Do not defeat the safety purpose of the polarized or grounding-type plug. A polarized plug has two blades with one wider than the other. A grounding-type plug has two blades and a third grounding prong. The wide blade or the third prong are provided for your safety. If the provided plug does not fit into your outlet, consult an electrician for replacement of the obsolete outlet.
10. Protect the power cord from being walked on or pinched particularly at plugs, convenience receptacles, and the point where they exit from the apparatus.

11. Only use attachments/accessories specified by the manufacturer.

12. Use only with a cart, stand, tripod, bracket, or table specified by the manufacturer, or sold with the apparatus. When a cart is used, use caution when moving the cart/apparatus combination to avoid injury from tip-over.



13. Unplug this apparatus during lightning storms or when unused for long periods of time.

	CAUTION	
RISK OF ELECTRIC SHOCK! DO NOT OPEN!		
CAUTION: TO REDUCE THE RISK OF ELECTRIC SHOCK DO NOT REMOVE COVER (OR BACK). NO USER-SERVICEABLE PARTS INSIDE. REFER SERVICING TO QUALIFIED PERSONNEL.		

The lightning flash with arrowhead symbol within an equilateral triangle means "electric shock hazard". It is intended to alert the user to the presence of uninsulated "dangerous" voltage within the product enclosure, that may be of significant magnitude to constitute a risk of electric shock to persons.

The exclamation point within an equilateral triangle means "Warning/Caution". It is intended to alert the user of the presence of important operating and maintaining (servicing) instructions in the literature accompanying the appliance.

14. Refer all servicing to qualified service personnel. Servicing is required when the apparatus has been damaged in any way, such as power-supply cord or plug is damaged, liquid has been spilled or objects have fallen into the apparatus, the apparatus has been exposed to rain or moisture, does not operate normally, or has been dropped.

15. This apparatus shall not be exposed to dripping or splashing, and no object filled with liquids, such as vases or beer glasses, shall be placed on the apparatus.

16. Do not overload wall outlets and extension cords as this can result in a risk of fire or electric shock.

17. The MAINS plug or an appliance coupler is used as the disconnect device, so the disconnect device shall remain readily operable.

NOTE: This equipment has been tested and found to comply with the limits for a Class B digital device, pursuant to part 15 of the FCC Rules. These limits are designed to provide reasonable protection against harmful interference in a residential installation. This equipment generates, uses, and can radiate radio frequency energy and, if not installed and used in accordance with the instructions, may cause harmful interference to radio communications. However, there is no guarantee that interference will not occur in a particular installation.

If this equipment does cause harmful interference to radio or television reception, which can be determined by turning the equipment off and on, the user is encouraged to try to correct the interference by one or more of the following measures:

- Reorient or relocate the receiving antenna.
- Increase the separation between the equipment and the receiver.
- Connect the equipment into an outlet on a circuit different from that to which the receiver is connected.
- Consult the dealer or an experienced radio/TV technician for help.

WARNING — To reduce the risk of fire or electric shock, do not expose this apparatus to rain or moisture.
--



CAUTION: Changes or modifications to this device not expressly approved by LOUD Technologies Inc. could void the user's authority to operate the equipment under FCC rules.

This apparatus does not exceed the Class A/Class B (whichever is applicable) limits for radio noise emissions from digital apparatus as set out in the radio interference regulations of the Canadian Department of Communications.

Exposure to extremely high noise levels may cause permanent hearing loss. Individuals vary considerably in susceptibility to noise-induced hearing loss, but nearly everyone will lose some hearing if exposed to sufficiently intense noise for a period of time. The U.S. Government's Occupational Safety and Health Administration (OSHA) has specified the permissible noise level exposures shown in the following chart.

According to OSHA, any exposure in excess of these permissible limits could result in some hearing loss. To ensure against potentially dangerous exposure to high sound pressure levels, it is recommended that all persons exposed to equipment capable of producing high sound pressure levels use hearing protectors while the equipment is in operation. Ear plugs or protectors in the ear canals or over the ears must be worn when operating the equipment in order to prevent permanent hearing loss if exposure is in excess of the limits set forth here:

Duration, per day in hours	Sound Level dBA, Slow Response	Typical Example
8	90	Duo in small club
6	92	
4	95	Subway train
3	97	
2	100	Very loud classical music
1.5	102	
1	105	The boss screaming at his minions about manual deadlines
0.5	110	
0.25 or less	115	Loudest parts at a rock concert

Laitte on liitettävä suojakoskettimilla varustettuun pistorasiaan.

Apparatet må tilkoples jordat stikkontakt.

Apparaten skall anslutas till jordat uttag.



Correct disposal of this product: This symbol indicates that this product should not be disposed of with your household waste, according to the WEEE directive (2012/19/EU) and your national law. This product should be handed over to an authorized collection site for recycling waste electrical and electronic equipment (EEE). Improper handling of this type of waste could have a possible negative impact on the environment and human health due to potentially hazardous substances that are generally associated with EEE. At the same time, your cooperation in the correct disposal of this product will contribute to the effective usage of natural resources. For more information about where you can drop off your waste equipment for recycling, please contact your local city office, waste authority, or your household waste disposal service.



TABLE OF CONTENTS

Important Safety Instructions	2-3
Table Of Contents	4
Introduction	4
Features	4
Scrambler Bass Overdrive Top Panel Features	5
Scrambler Bass Overdrive Rear and Bottom Panel Features.....	6
Scrambler Bass Overdrive Bottom Panel Features.....	7
Scrambler Bass Overdrive Suggested Settings	8
Scrambler Bass Overdrive Block Diagram.....	9
Technical Specifications / Service Information.....	10

Introduction

The Ampeg Scrambler Bass Overdrive pedal infuses your sound with authentic Ampeg grit, grind and sag. Dial in a huge range of overdrive from subtle to screaming. Add in a touch of highs, then blend in with your dry signal to create the perfect tone. It's pure analog Ampeg overdrive that's super affordable.

Like all Ampeg products, your Scrambler Bass Overdrive pedal is designed by musicians and built using only the best of components. Each pedal is tested to confirm that it meets our specifications, and we believe that this pedal is the absolute best that it can be.

In order to get the most out of your new pedal, please read this manual before you begin playing. Best of luck in all of your musical endeavors!

And **thank you** for choosing Ampeg.

Features:

- Delivers classic Ampeg grit, grind and sag.
- Separate drive and blend (wet/dry) control.
- Treble and volume control.
- True bypass, analog design with incredible signal-to-noise ratio.
- Roadworthy all-metal chassis construction.
- 9V DC supply or battery capable (not included).

 Like us

 Follow us

 Watch our dang videos



Scrambler Bass Overdrive Top Panel Features

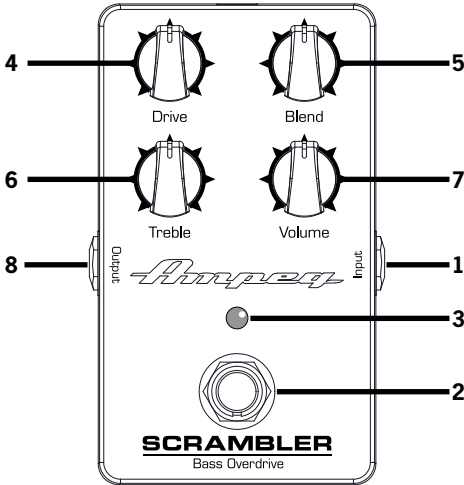

1. **INPUT:** The signal output from an instrument (active or passive) may be connected to this 1/4" input by means of an unbalanced shielded instrument cable.
NOTE: There is a -15 dB pad jumper located inside of the pedal. Details on switching the jumper may be found on page 7.
NOTE: Unplug the input cable when not in use, as the 9V battery will drain (and eventually die). Details on replacing the battery may be found on page 7.
2. **SCRAMBLER SWITCH:** Engage this switch to activate the Scrambler pedal. This pedal is true bypass meaning the signal will pass through from input to output with no circuitry in between when the switch is disengaged.

3. **ON/OFF LED:** This LED illuminates purple when the pedal is engaged.
4. **DRIVE:** Use this to adjust the amount of Bass Scrambler™ overdrive effect. Rotate the control clockwise for a more overdriven sound, or counter-clockwise for a less overdriven sound.
5. **BLEND:** Use this to blend the Bass Scrambler™ affected signal with the clean unaffected signal.
6. **TREBLE:** Use this to adjust the high frequency level. This provides up to 17 dB of boost, or 14 dB of cut at 4 kHz. The high frequency output is flat at the center position.
7. **VOLUME:** Use this to control the overall output level. Use it wisely, and turn it down when making connections or trying something new. Unity is at 12:00.
NOTE: The volume control is active only when the pedal is engaged.
8. **OUTPUT:** Typically, this 1/4" output jack connects to the input of an external power amplifier – or powered loudspeakers, as long as they have their own input controls to adjust the volume level – by means of an unbalanced shielded instrument cable. However, it may be connected to an external mixer, recorder, or interface. In this way, you do not have to mic the speaker cabinet in order to add it to the main mix, or to record. The level of the signal is affected by the volume control.



Scrambler Bass Overdrive Rear and Bottom Panel Features

9. POWER CONNECTOR: This is where to connect the optional power supply.

 Before plugging in the power supply, make sure that you are using the correct one for your country (see below).

NOTE: A power supply may be purchased at your local Ampeg Dealer or ordered directly from LOUD Technologies Inc. Be sure to ask for part number:

- 2045758-00: United States
- 2045758-01: Europe
- 2045758-02: Japan
- 2045758-03: United Kingdom
- 2045758-04: Australia
- 2045758-05: China
- 2045758-06: Brazil

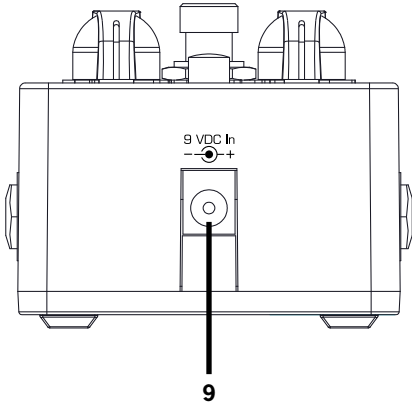

BOTTOM PANEL ACCESS

A -15 dB pad jumper is located inside the bottom of the pedal. This is also where the 9V battery is housed.

Removing the bottom is easy. Simply start by placing the pedal top down on a soft, dry cloth.

Remove each of the four screws by turning them counter-clockwise. Be sure to keep them in a safe place as you will need them again!

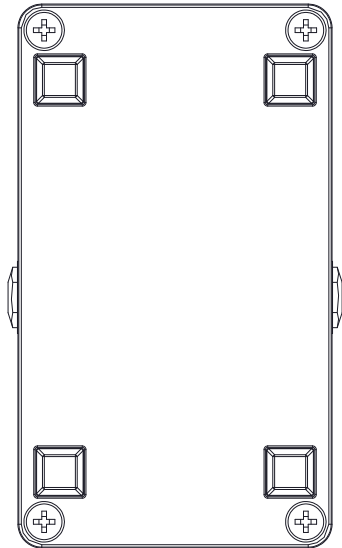



Scrambler Bass Overdrive Bottom Panel Features

10. 9V BATTERY

The Scrambler Bass Overdrive may be powered by 9V battery instead of using a power supply. As seen in the illustration below, it tucks in nicely inside a compartment of the circuit board next to the edge of the pedal.

NOTE: Unplug the input cable when not in use, as the 9V battery will drain (and eventually die).

NOTE: When replacing the bottom of the pedal, line up the rectangular foam piece over the battery. Turn the screws clockwise to affix to the bottom to the pedal.

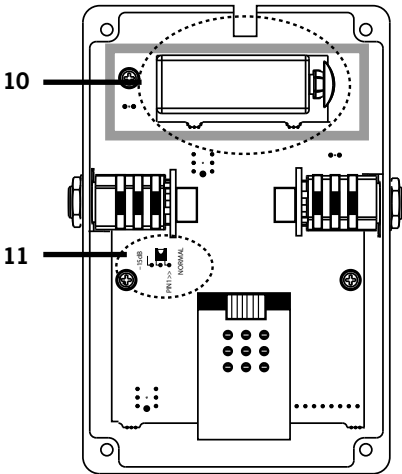

11. -15 dB PAD JUMPER

Moving the -15 dB pad jumper reduces the input signal by 15 dB and compensates for higher output instruments. This attenuation is suited for use with basses that have active electronics or high-output pickups.

There are only two possibilities. The jumper can be on:

- Pins 1-2 [Normal – default] or
- Pins 2-3 [15 dB pad]

Ok, ok...there could be no jumper, but that just sets the pedal to its normal/default [pins 1-2] setting (with about 1/2 dB loss).

Referencing the diagram to the left, slide the jumper out then back in on the pins that you want to use for your instrument. Fingers should work just fine, but it's ok to use needle-nose pliers to remove the jumper, if necessary.

NOTE: When replacing the bottom of the pedal, line up the rectangular foam piece over the battery. Turn the screws clockwise to affix to the bottom to the pedal.

NOTE: If you are experiencing excessive distortion – distortion begins at approximately 0.5 Vrms – then you might want to utilize the 15 dB pad by moving the jumper to pins 2-3.

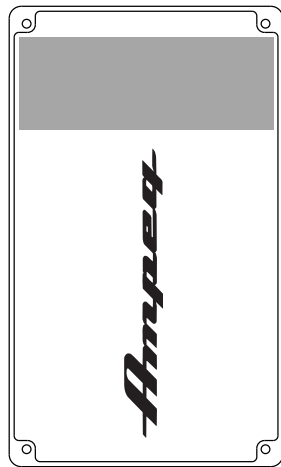



Scrambler Bass Overdrive Suggested Settings

* Volume to taste

Blow Your Face Off

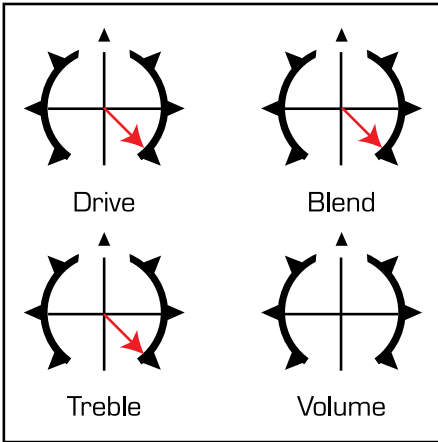

Heavy Pick

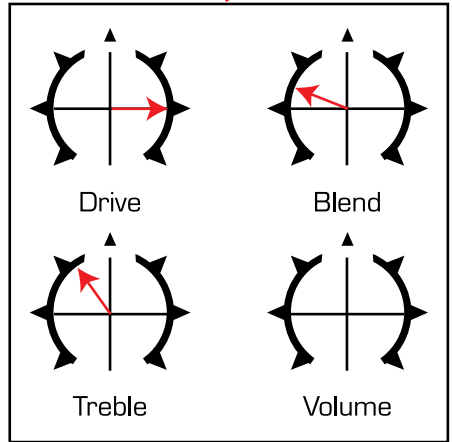

Mild SVT Grind

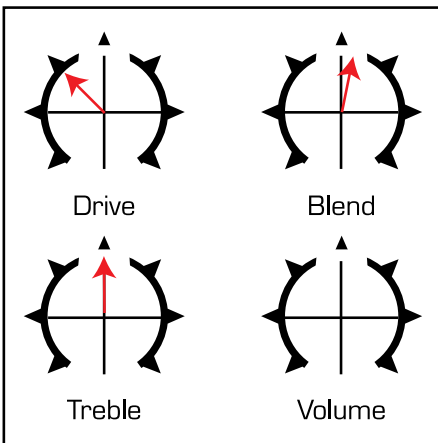

Mild Overdrive

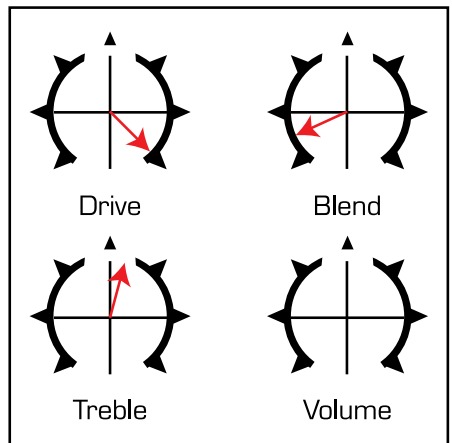



Scrambler Bass Overdrive Block Diagram

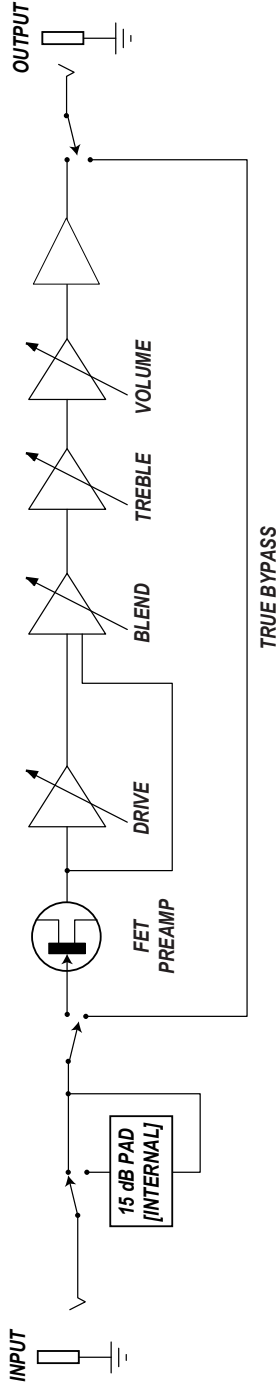

SCRAMBLER BASS OVERDRIVE TECHNICAL SPECIFICATIONS

Signal to Noise Ratio (50 Hz @ 300 mV RMS)	>85 dB
Maximum Gain	+18 dB
Tone Controls	Treble: +17/-14 dB @ 4 kHz
Impedances	Input: 1 M Ω @ NORMAL, 83 k Ω w/-15 dB PAD Output: 120 Ω
Power Requirements	Internal: 9 V Battery External: 9 VDC, \geq 20 mA
Size (H x W x D)	2.2 in x 2.6 in x 4.5 in 56 mm x 66 mm x 114 mm
Weight	0.6 lb / 0.3 kg (approximately)

Service Information

If you are having a problem with your Scrambler Bass Overdrive, you can go to our website (www.ameg.com) and click on Support for service information, or call Technical Support at 1-800-898-3211 Monday-Friday during normal business hours, Pacific Time, to receive assistance. If you are outside of the U.S., contact your local distributor for technical support and service.

The Scrambler Bass Overdrive is housed in a corrosion resistant die-cast zinc chassis, so be sure to clean it with a dry lint-free cloth. Never spray cleaning agents on the Scrambler Bass Overdrive. Avoid abrasive cleansers which would damage the finish.

Ampeg continually develops new products and improves upon existing ones. For this reason, the specifications and information in this manual are subject to change without notice.

"Ampeg" is a registered trademark of LOUD Technologies Inc. All other brand names mentioned are trademarks or registered trademarks of their respective holders and are hereby acknowledged.

Amper

Scrambler Bass Overdrive

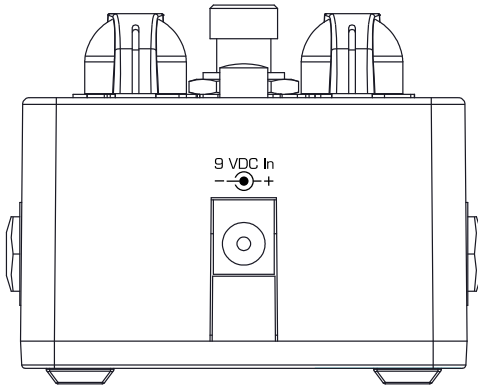

Owner's Manual